

series 18 heavy duty stage track technical data sheet

S18-4185 rev 3

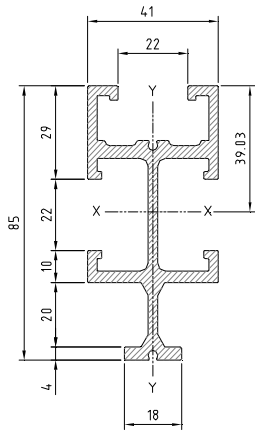

track section 8541

registered design AU 156590

area	827 mm ²
Ixx	526400 mm ⁴
Iyy	129254 mm ⁴
rx	25.23 mm
ry	12.5 mm
material	aluminium 6060 T5
0.2% proof	110 MPa
UTS	150 MPa
mass	2.223 kg/m (13.34kg/6m)
finish	black anodised 15µm

recommended support centres 2.5m (3m max) without lateral support

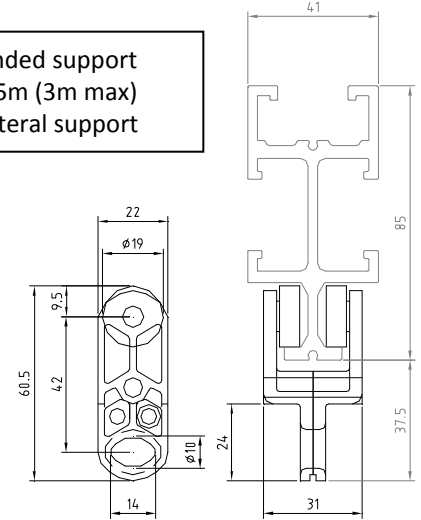

runner

registered design AU 156591

body material	glass reinforced nylon - black
wheels	ball bearing, acetal tyre -black
capacity	12kg @ 0.5 m/s
mass	28g

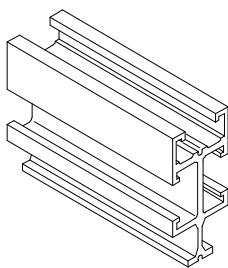

6m std length
18-8541-6

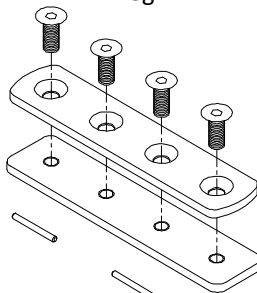

joint set 18-85-24



runner
18-00-01



runner bumper
18-00-01-b

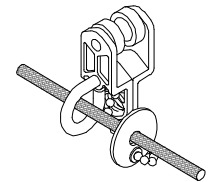

rear fold runner
18-00-01-RF

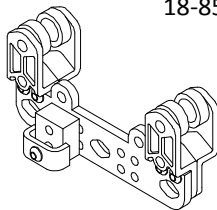

master carrier
18-00-02

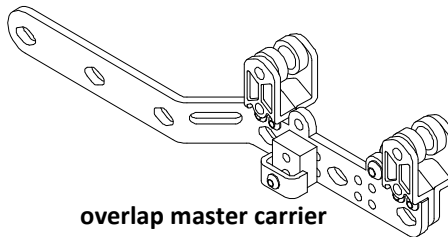

overlap master carrier
18-00-03

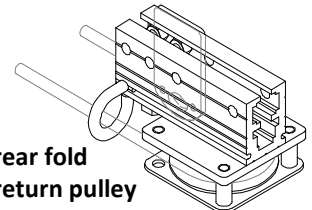

rear fold return pulley
18-00-07-RF

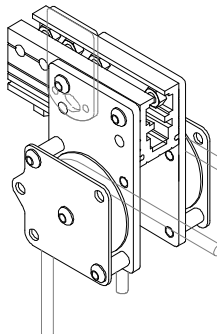

head pulley
18-00-06

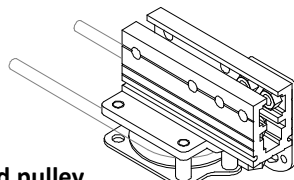

return pulley
18-00-07

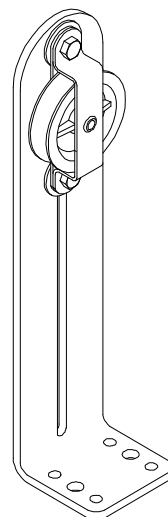

adjustable floor pulley
18-00-15

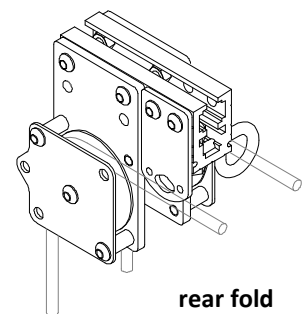

rear fold head pulley
18-00-06-RF

side entry head pulley
18-00-06

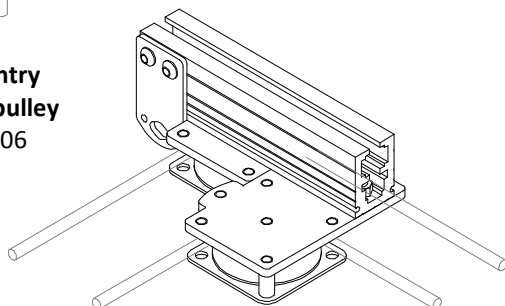

rear fold end stop
18-00-18-RF

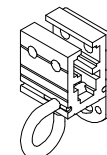

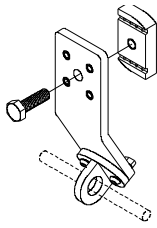

line guide 18-85-40

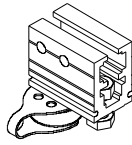

pulley line guide 18-00-20

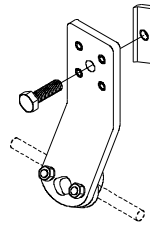

outrigger guide 18-85-39

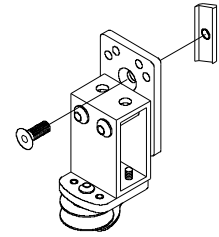

outrigger pulley 18-85-22

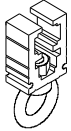

compact
end stop - eye
18-00

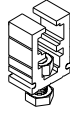

compact
endstop
18-00

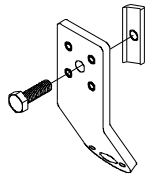

end stop-eye
18-85-41

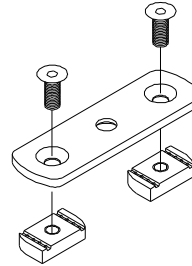

overlap clip 18-00-27

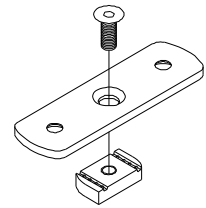

soffit mounting clip
18-00-29

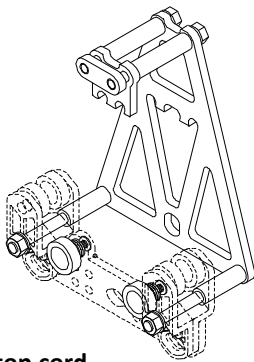

top cord
master carrier bracket 18-85-04

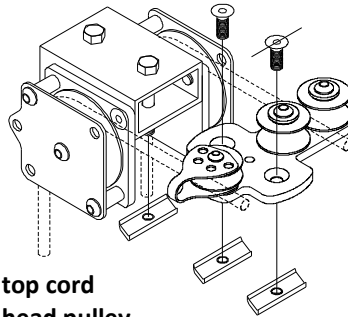

top cord
head pulley
18-85-08

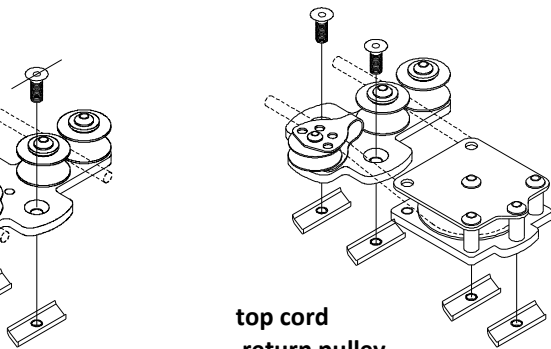

top cord
return pulley
feeder 18-85-12

top cord
return pulley
18-85-09

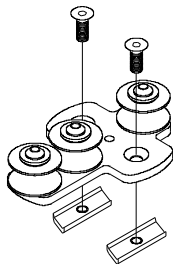

top cord
cord guide pulley
18-85-13

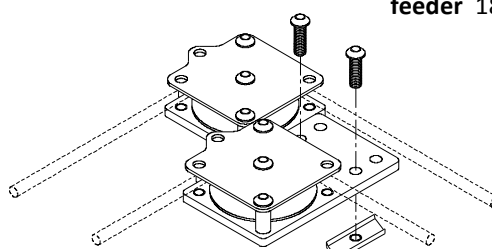

top cord
side entry head pulley
18-85-

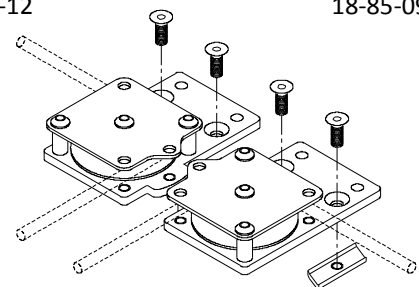

top cord
side entry pulley 18-85-

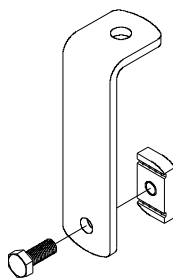

top cord
hanger bracket
18-85-31

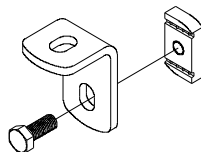

soffit mount
hanger bracket
18-85-35

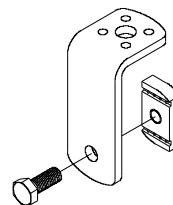

stand-off bracket
18-85-42

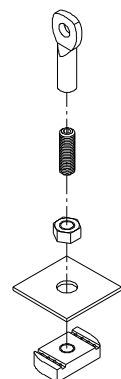

eyebolt
hanger
assembly

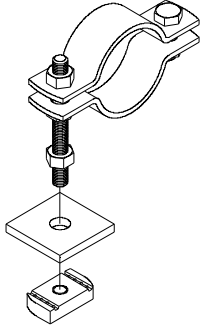

batten clip & threaded rod hanger assemblies

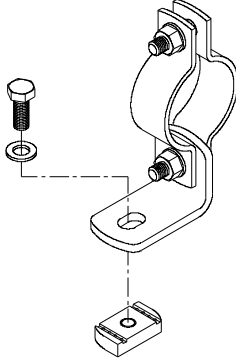

batten clip & angle bracket
18-00-36



eyebolt hanger assembly



threaded rod hanger assembly

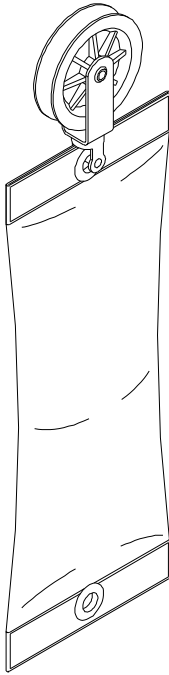

weight pulley
18-00-34

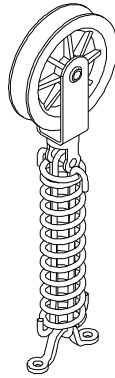

spring loaded floor pulley
18-00-16

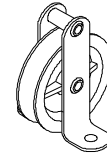

plain floor pulley
18-00-14

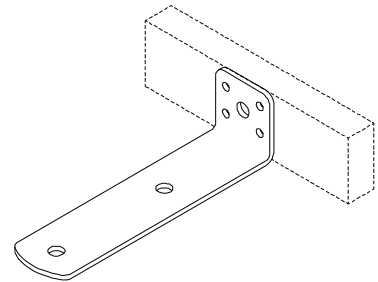

valance bracket 160/80mm
18-00-43

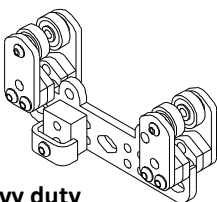

heavy duty master carrier
18-00-10

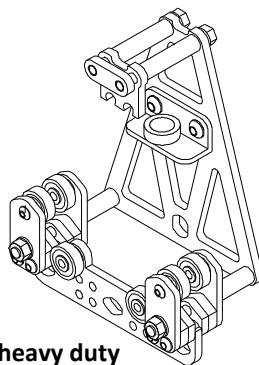

heavy duty top cord master carrier assembly

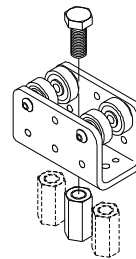

heavy duty scenery carrier
18-00-37

