

**series 18 heavy duty stage track** technical data sheet

S18-4185 rev 1

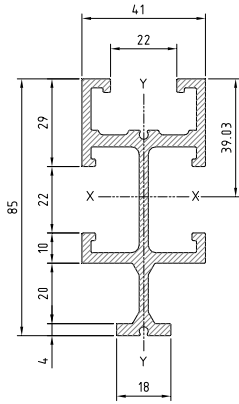

**track section 4185**  
registered design AU 156590  
area 827 mm<sup>2</sup>  
Ixx 526400 mm<sup>4</sup>  
Iyy 129254 mm<sup>4</sup>  
rx 25.23 mm  
ry 12.5 mm  
material aluminium 6060 T5  
0.2% proof 110 MPa  
UTS 150 MPa  
mass 2.223 kg/m (13.34kg/6m)  
finish black anodised 15µm

recommended support  
centres 2.5m (3m max)  
without lateral support

**runner**  
registered design AU 156591  
body material glass reinforced nylon - black  
wheels ball bearing, acetal tyre -black  
capacity 12kg @ 0.5 m/s  
mass 28g

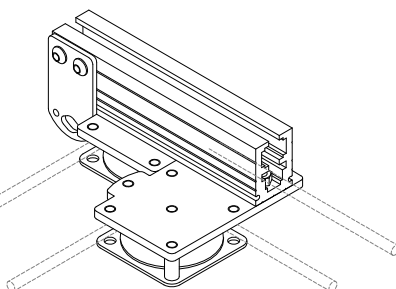
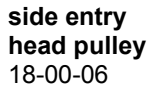
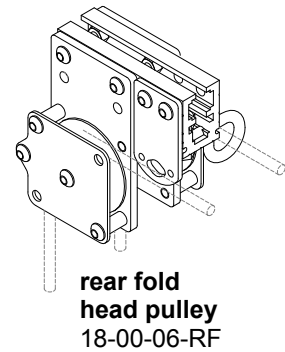
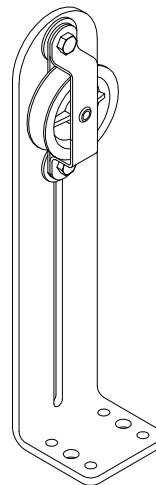
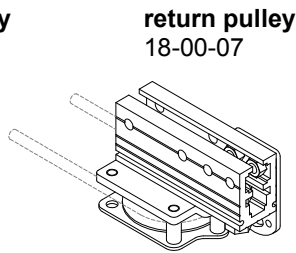
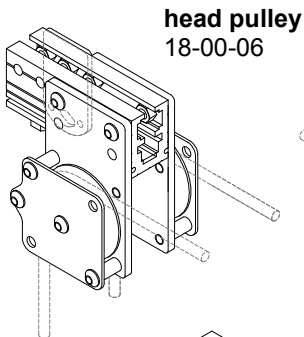
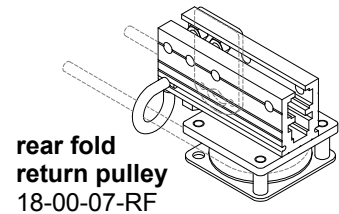
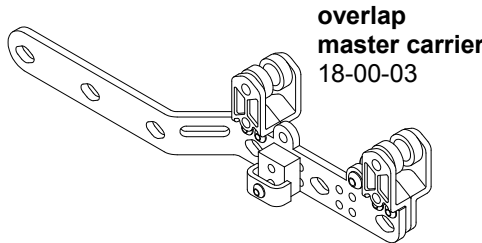
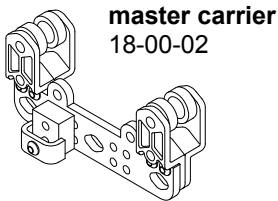
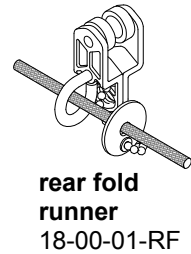
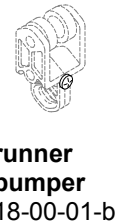
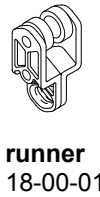
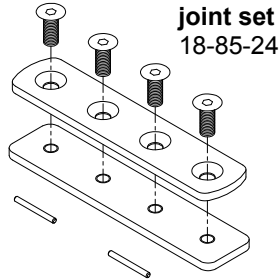
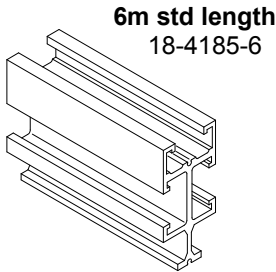
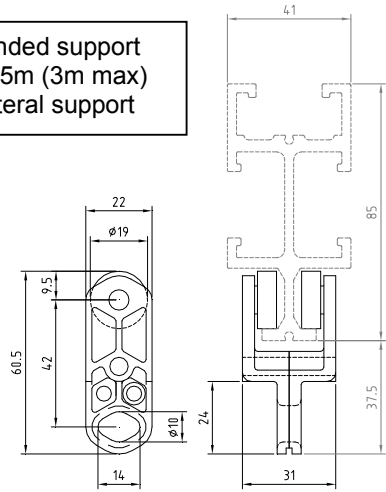

s18-4185data rev1.doc

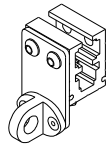

**line guide**  
18-00-19

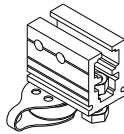

**pulley line guide**  
18-00-20

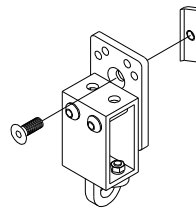

**outrigger guide**  
18-00-21-A

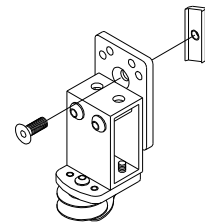

**outrigger pulley**  
18-00-21-B

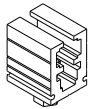

**end stop - plain**  
18-00-17

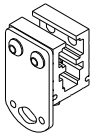

**end stop - eye**  
18-00-18

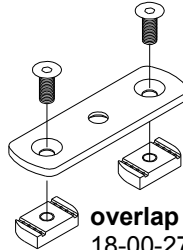

**overlap clip**  
18-00-27

**soffit mounting clip** 18-00-29

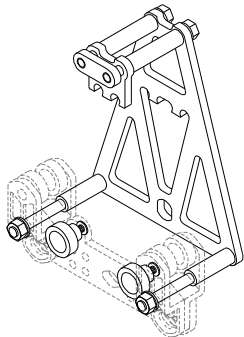
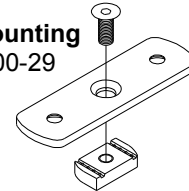

**top cord master carrier bracket**  
18-85-04

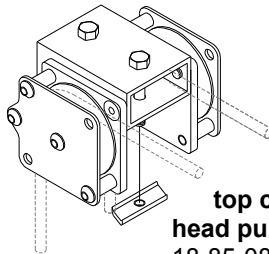

**top cord head pulley**  
18-85-08

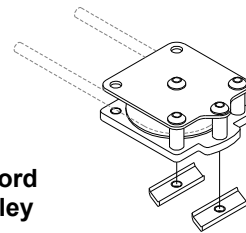

**top cord return pulley**  
18-85-09

**top cord hanger bracket - pivot** 18-00-

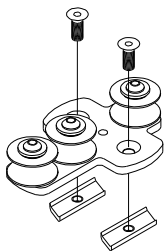
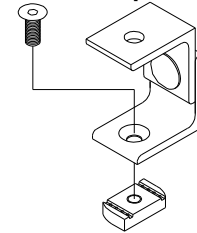

**top cord cord guide pulley**  
18-00-13

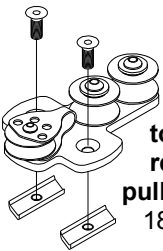

**top cord return pulley feeder**  
18-00-12

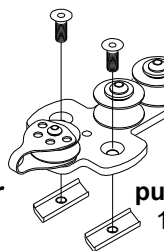

**top cord head pulley feeder**  
18-00-12

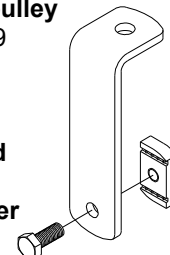

**top cord hanger bracket**  
18-00-

**top cord side entry head pulley**  
18-00-

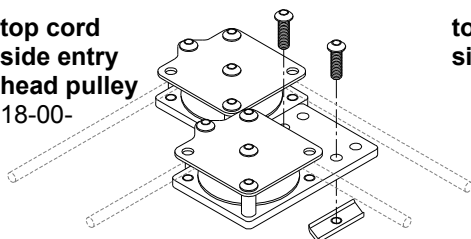

**top cord side entry pulley**  
18-00-

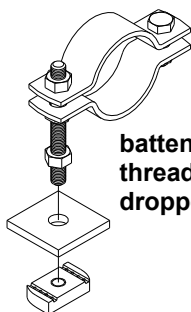
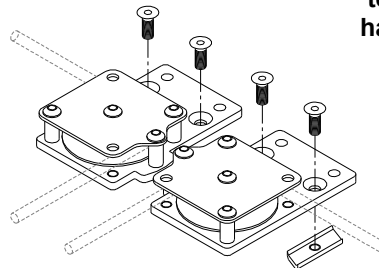

**batten clip & threaded rod dropper**

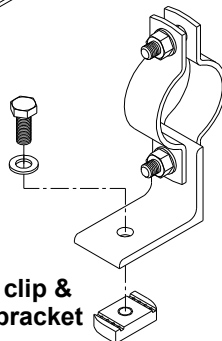

**batten clip & angle bracket**

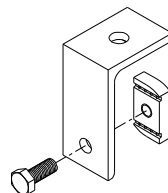

**stand-off bracket**

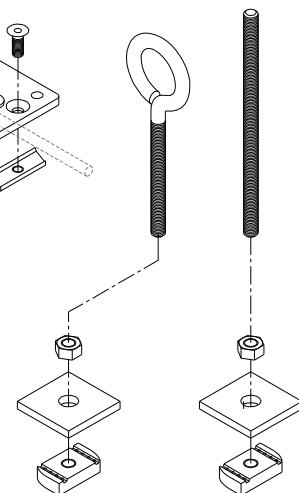

**eyebolt assembly**

**threaded rod assembly**